

**Panasonic**  
ideas for life



## Office Communication Systems

**KX-TDE100**  
**KX-TDE200**

**New Telephony Systems Offering Solid IP Solutions**

# The Panasonic Full-IP PBX Debuts Together with Versatile New IP Phones.

## A Pure IP PBX for an IP Platform and Traditional Telecom Lines.

Today's offices are shifting from traditional telecom systems to low-cost, flexible IP systems that take full advantage of the rapid growth in IP applications and globalisation. The KX-TDE100 and KX-TDE200 can be used to construct a full-IP telecom system, making them a perfect match for these new communications systems. The KX-TDE100 and KX-TDE200 offer new, standard-equipped IP functions that boost efficiency and lower communication costs.

They also include convenient and highly effective features such as wireless operation, voice mail and CTI. For companies planning to switch to a full-IP system, Panasonic IP-PBX systems offer a scalable, easy-to-use platform that adapts to a wide range of business fields for future expansion. In addition, these models also support traditional telecom lines, so they allow IP systems to be integrated with conventional telecom systems such as ISDN and analogue lines. Depending on the

office environment, it may be difficult to switch an existing traditional telecom line to a full IP system all at once due to time and cost restrictions. The KX-TDE100 and KX-TDE200 respond flexibly to needs like this. By changing the main board in the current TDA series, a new system can be easily constructed. This lets the KX-TDE100 and KX-TDE200 provide optimal solutions for companies that want to smoothly migrate to an IP system while continuing to use their existing telecom network.

## Key features of the Panasonic KX-TDE100/TDE200

### Full-IP compatibility

Low-cost, flexible IP system construction

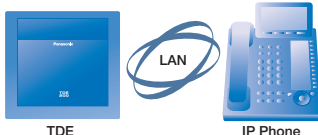

Using an IP network to reduce costs.

### Outstanding versatility

Because the KX-TDE100/TDE200 are compatible with existing infrastructure (Analogue/ISDN lines, etc.), they are ideal for offices that want a phased migration to an IP system.



Partial incorporation of an IP system into a traditional telecom system. Switching to a full-IP system in the future.

### Attractive system for TDA users

The functions of the newest TDE series can be used by simply replacing IPCMPR Card.

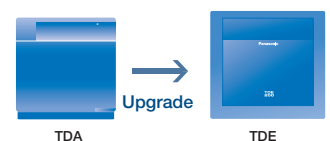

# Integrated Office Solutions and Business Productivity.

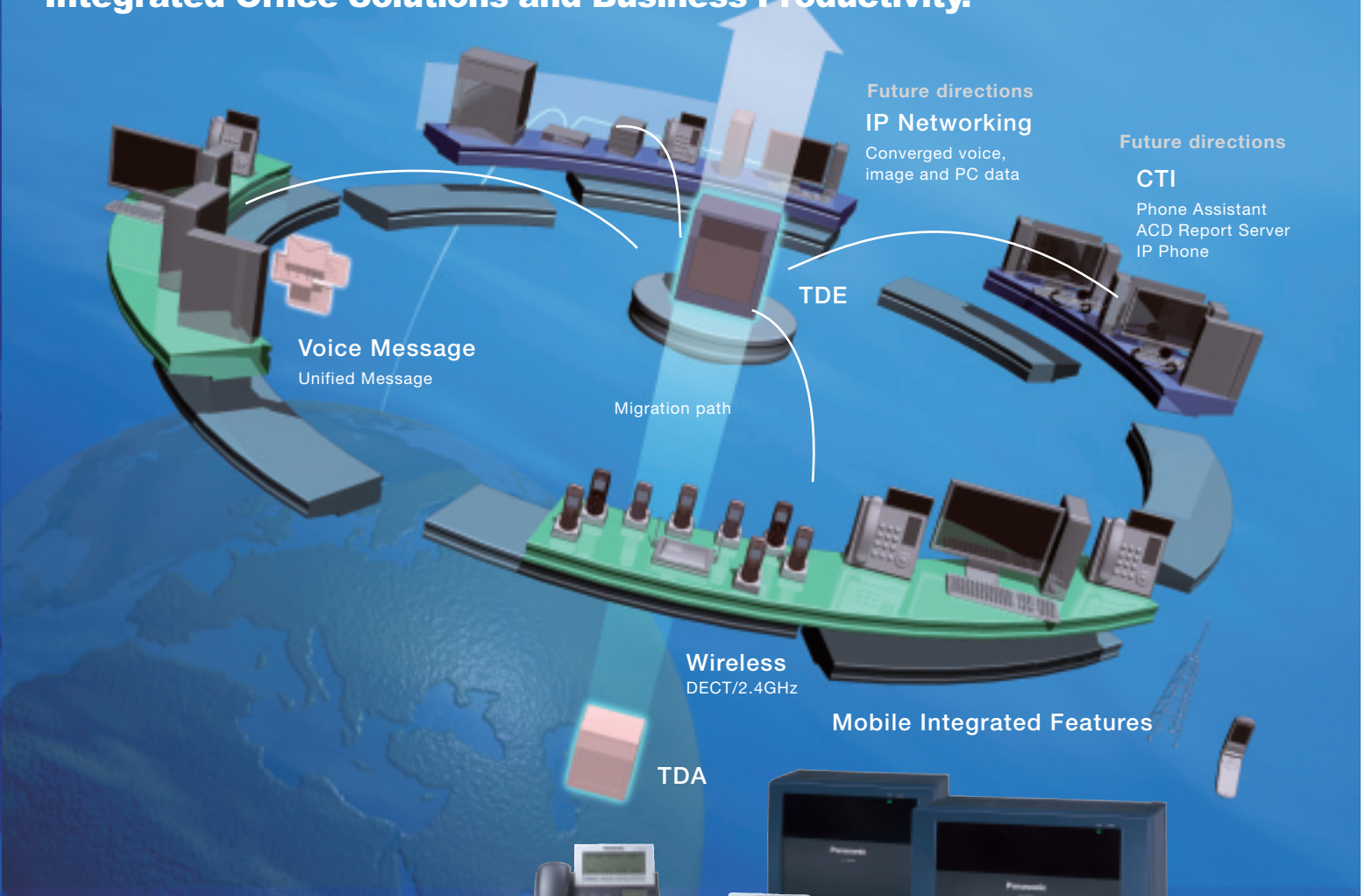

## Easy setup and maintenance

The TDE uses the same PC programming software operation that is used in the TDA series and supports multi-site programming. It is able to manage up to four TDEs on the network by PC operation.

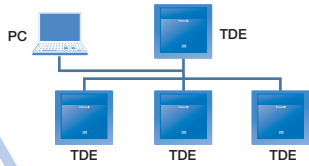

Central management of remote sites.

## Panasonic PBX IP Migration Strategy

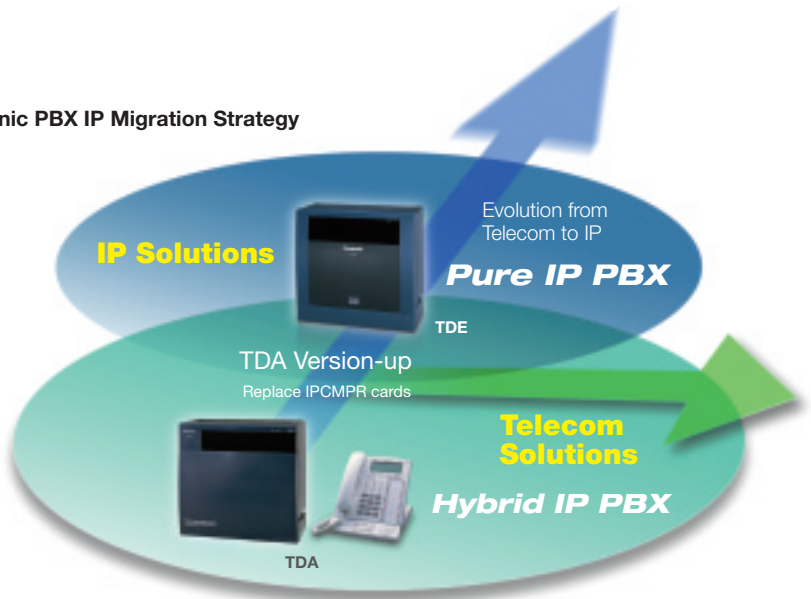



## Panasonic TDE Series... Power Enhancing Features

The KX-TDE series Pure IP PBXs are advanced corporate communication systems providing IP telephony features and functionalities over both local and broadband IP networks.

They are an ideal communication platform to help customers solve all their business telephony needs today as well as in the future as they embrace full IP telephony, empowered with the latest SIP technology.

### New IP Features in the TDE

- **Full-IP compatibility**
  - Up to 64 IP-proprietary telephones and 32 IP-trunks with the optional DSP card.
  - Up to 128 standard SIP phones.
- **Support for the new IP-PT KX-NT300 series**
- **Fully equipped with KX-TDA functions and solutions**
- **Server connection**

The TDE series will connect DHCP/SNTP servers and SNMP manager as either client or agent.
- **Enhanced walking extension**
- **Built-in Simplified Voice Message**
- **Easy Maintenance**
  - Using a PC Programming Software, with the same method as the TDA series.
  - 2 Built-in LAN ports
- **Multi-site Programming (up to 4 sites)**

### Ideal for TDA Series users

- Uses TDA's option cards and inherits its easy operation.
- Simple setup
- Easy maintenance
- Full support of TDA features
- Upgradeable to TDE by changing the main card (IPCMPR card) in the TDA

### Full-IP compatibility

Allows the use of an IP trunk line (H.323) and an SIP trunk, IP-PTs, IP softphone, and SIP extension.

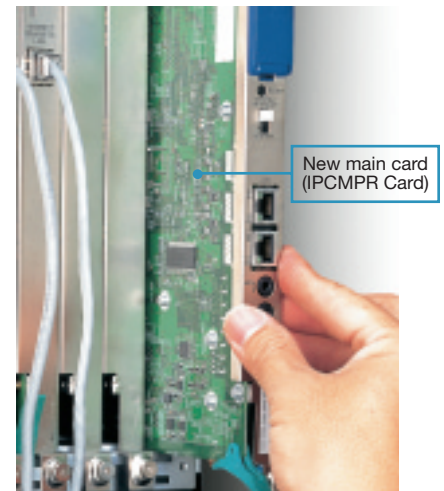
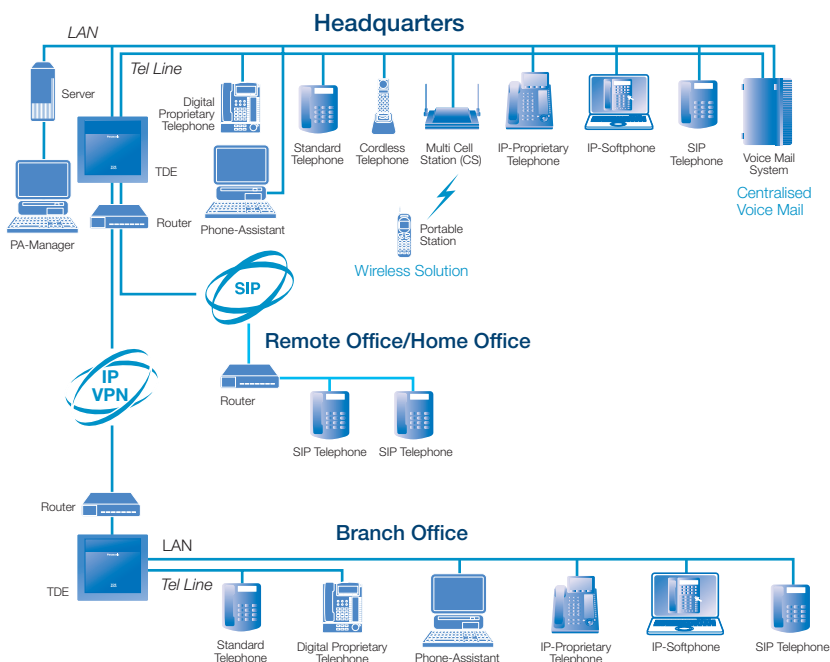

Upgrade from TDA to TDE



## Server connection

The TDE supports the connection of the following, allowing for enhanced efficiency and record keeping.

- DHCP client for TDE
- SNMP Agent/Alarm
- SNTP client

## Enhanced walking extension (Hot Desking)

It is possible to use any extension, and to have your extension setting available whenever you want it. This is a very useful feature when...

- You move locations
- There is no specific desk for you to use.

## Built-in Simplified Voice Message

KX-TDE is preinstalled with the simplified Voice Mail feature (2 channels).

Allowing for simple answering machine service.

## Easy Maintenance

- Using a PC Program, with the same method as the TDA series.
- 2 Built-in LAN ports

## Multi-site Programming

Up to four TDEs can be programmed by one PC at the same time when each TDE connected to the network.

This function also makes it easy to set all of the PBX programs at the same time.

## Best match with the new KX-NT300 Series for IP telephony

- Self labelling display (Only KX-NT366)
- Bluetooth® Module for hands-free talking
- Add-on 12-key/60-key modules (Only KX-NT346 and KX-NT343)
- Peer-to-Peer connection
  - Reduced load on VOIP resources in the main PBX unit
- High sound quality (G.722 codec) between KX-NT300 series



### TDE and TDA Comparison

Item		KX-TDA Series	KX-TDE Series
IP Trunk	H.323	YES (VPN)	YES (VPN)
	SIP	NO	YES
IP Extension	MGCP	YES	YES
	SIP	NO	YES
	Peer-to-Peer	NO	YES
Proprietary Telephone	NT300 Series	NO	YES
	NT136/256	YES	YES*1
	T76 Series	YES	YES
	T77 Series	YES	YES
Linkage with server	DHCP	NO	YES
	SNMP	NO	YES
	SNTP	NO	YES
Wireless (DECT)	8CH CS	NO	YES

\*1 The TDE requires IP-Extension Card for NT136 and NT265. Upgraded NT265 (Ver.2.00 or later software) is supported without IP-Extension Card.

# Proprietary Telephones for an Easy Touch

## Panasonic's New IP Telephones... Attractive Features

Ergonomic designs offer the ultimate in easy operation.  
Literally filled with comprehensive IP telephony functions.

### New Features

- **Stylish Universal Design concept**  
Free tilt angle (Double tilt adjustment for phone base and LCD).  
The phone base and LCD tilt to easy-to-view angles.
- **Self labelling (Only KX-NT366)**
- **Hands-free talking with a Bluetooth® Headset**
- **Peer-to-Peer Connection**
- **Navigator Key**
- **Second Ethernet Port**
- **Flexible CO Buttons**



### Peer-to-Peer Connection

Direct communication between KX-NT300 series is available after the communication was established by TDE series. And Peer-to-Peer communication reduces network traffic and PBX's resource.

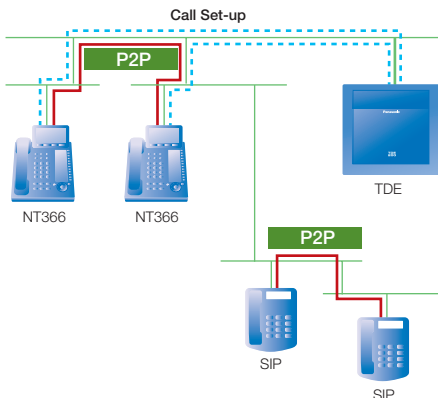

### Self Labelling LCD (Only KX-NT366)

The KX-NT366 IP-proprietary telephone features 12 flexible buttons, with an LCD screen next to the buttons. Each item can be named on the LCD screen through personal or system programming to reflect the function of its corresponding flexible button. Plus, a total of 48 functions can be assigned to the 12 flexible CO buttons. Pressing the "NEXT PAGE" key toggles between pages.

\*These features are available only on the KX-TDE100 and KX-TDE200.

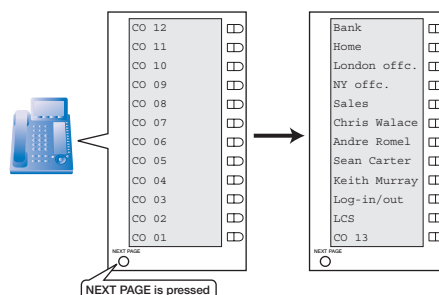

### Hands-Free Communication with a Bluetooth® Headset

Mounting the KX-NT307 lets you connect a commercially available Bluetooth® headset for hands-free communication (Answer a call/End a call/Voice communication). This makes it possible to operate a PC during conversations and to communicate comfortably at a distance from the telephone.







## New IP Proprietary Telephone Line-up

### KX-NT366

- 6-Line Backlit Display
- 4 x 12-Self Labelling, Flexible CO Buttons
- Digital Speakerphone
- 2 Ethernet Ports (100 Base-T)
- Power-over-Ethernet (PoE)
- Bluetooth® Module (Option)

6-Line LCD & Self Labelling

### KX-NT346

- 6-Line Backlit Display
- 24 Flexible CO Buttons
- Digital Speakerphone
- 2 Ethernet Ports (100 Base-T)
- Power-over-Ethernet (PoE)
- Bluetooth® Module (Option)
- Add-on 12-Key Module (Option: KX-NT303) or Add-on 60-Key Module (Option: KX-NT305)

6-Line LCD

### KX-NT343

- 3-Line Backlit Display
- 24 Flexible CO Buttons
- Digital Speakerphone
- 2 Ethernet Ports (100 Base-T)
- Power-over-Ethernet (PoE)
- Bluetooth® Module (Option)
- Add-on 12-Key Module (Option: KX-NT303) or Add-on 60-Key Module (Option: KX-NT305)

3-Line LCD



## More Features

#### • Navigator Key

The Navigator key allows fast, one touch access to multiple phone system functions. The ergonomically designed navigation key makes it easy to go through phone system feature menus.

#### • Second Ethernet Port

Reduce cable clutter on your desktop and reduce cost of cabling by using the built-in second Ethernet port to connect your personal computer (or other IP network device) to the IP network without the cost of additional cabling.

#### • Flexible CO Buttons

One-touch function access Flexible CO Buttons save time and effort. These keys can be used to store telephone numbers, or access frequently used phone system features.

#### • Add-on 12/60-CO Key Module Connection

Add-on 12/60-CO Key Module works as not only DSS keys but also Flexible CO Buttons. KX-NT303/NT305 Add-on 12/60-CO Key Module is connected directly to KX-NT346 and KX-NT343. Self-Labeling model KX-NT366 does not support this Module.

## Options

### Add-on Key Module

#### KX-NT303

- Add-on 12-Key Module (For KX-NT346 and KX-NT343 only)

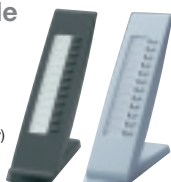

#### KX-NT305

- Add-on 60-Key Module (For KX-NT346 and KX-NT343 only)



### Bluetooth® Module

#### KX-NT307



## Panasonic Wireless Solutions... Flexible Communication

The TDE's wireless solutions enhance mobility and flexibility for offices, healthcare, big shops, etc.

### Wireless for TDE series

Panasonic Office Communication Systems allow wireless communication over an extended range by using multiple cell stations that boost the flexibility and mobility of your wireless handset. Using the Wireless XDP, you can set your wireless telephone to have the same extension as your desk phone, and then receive calls even when you are away from the desk. You are always there, ready to receive customer calls, and make the most of every business opportunity that comes along.

### Benefits of Wireless Telephone Integration

- Up to 128 handsets can be connected to one system
- Secure high-quality speech reproduction and excellent reliability
- Caller ID name and number compatibility\*
- Programmable multiple ring patterns, including vibrate mode

\*Requires subscription to a fee-based telephone service.



## DECT

### KX-TCA155, KX-TCA256 and KX-TCA355

- 6-line blue LCD backlight
- Illuminated keypad
- Multiple language display
- Speakerphone
- Programmable soft keys
- PBX functionality support
- 200 entry phonebook
- Headset compatible
- 9 polyphonic ringer melodies and 6 ringing patterns
- Vibrate alert\*
- Meeting mode\* \*Only KX-TCA355, 256

Basic Model



KX-TCA155

Compact Business Model



KX-TCA256

Tough-type Model  
(IP54 compliant)



KX-TCA355





### Business Class Wireless DECT mobility for Your Panasonic PBX System

The Tough Type KX-TCA355 handset meets strict dust- and splash-resistant IP54 standards and offers a vast array of business telephony features. The KX-TCA256 DECT handset combines small size and light weight with a host of powerful business telephony features. And the KX-TCA155 is an excellent choice for users who want great basic performance at a lower cost.

\*The KX-TCA355, KX-TCA256 and KX-TCA155 must be connected to a compatible Panasonic Phone System (KX-TDE100/200, KX-TDA30/100/200/600).

#### As for KX-TCA355 Tough Type Model

- IP5\*= Dust resistance (Protection from dust penetration to a level that does not interfere with the operation of the handset)
- IP\*4= Water resistance (Protection against splashing water)  
The Panasonic KX-TCA355 DECT Handset complies to UKAS IP54 testing standards.
- Impact absorbing rubber is adopted around the KX-TCA355.
- The cabinet (outer plastic covering) is also used impact-touch materials.

Impact-absorbing rubber installed on the entire circumference

External cabinet made of impact resistant material



## High-Density Cell Station

### KX-TDA0158

- The KX-TDA0158CE supports eight speech paths.



KX-TDA0158

## Cell Stations

**KX-TDA0141**  
DPT I/F Cell Station  
2 speech path

**KX-TDA0142**  
CS I/F Cell Station  
4 speech path



## Repeater (KX-A272)

Used with Repeater, the range can be extended.  
A maximum of six repeaters per CS are available.

#### DECT Required Equipment and Maximum Number of Calls

CS	Connection Card	Maximum Calls	Compatible PSs
KX-TDA0158CE	DHLC,DLC	8	KX-TCA155
KX-TDA0141CE	DHLC,DLC	2	KX-TCA256
KX-TDA0142CE	CS I/F	4	KX-TCA355

#### Maximum Terminal Equipment

The following shows the number of each terminal equipment type supported by the PBX

Terminal Equipment Type	KX-TDE100	KX-TDE200
Basic CS	32	32
High-density CS	16	16
PS	128	128

## Providing customers with intelligent call handling through Computer Telephony Integration (CTI).

Phone Assistant enhances personal, team and business productivity.

### CTI from Panasonic

Panasonic CTI comprises both 1st Party CTI (via USB connection) and 3rd Party CTI (via LAN connection), to provide customers with unique Panasonic applications, such as Phone Assistant/ACD report server, and other customised software utilities employing TAPI/CSTI interfaces. Connecting a PC to a DPT, or connecting a CTI Server to our PBX, enables extension users to make use of advantageous features by using the stored data in the PC or the CTI Server.

The features that are available through CTI depend on the CTI application software used on the connected PCs.

#### 1. Using USB — 1st Party Call Control

A PC is connected to a DPT via a USB port (USB module) on the DPT. The PC monitors and controls the DPT.

#### 2. Using LAN — 3rd Party Call Control

A CTI Server is connected to the PBX using the LAN port of an IPCMPR card as a CTI interface. PCs monitor and control the PBX via the CTI Server.

#### Application Programming Interface (API)/Protocol

The following interfaces are required for 1st and 3rd Party Call Control.

Type	API/Protocol
1st Party Call Control	TAPI 2.1
3rd Party Call Control	ECMA CSTA Phase 3 TAPI 2.1

### Phone Assistant for Personal Productivity - Easy Access to Phone Features

By providing on-screen call related information like Caller ID, Calling Party's Name and allowing users to simply point-n-click or use keyboard shortcuts to quickly handle calls - users are able to do more in less time increasing personal productivity.

#### Confirm colleague availability and presence

It helps in determining who is available to handle calls before you decide to call them, greatly reducing the number of unanswered calls.

#### Easy access to system phone functions

Wizards appear as and when you need them, helping you with most common telephony features like Transfer, Forward, Do-Not Disturb, Hold, Park, and Conference call set up.

#### Dial easily through your database

Users can create their own business and private contacts, show the presence and availability of all co-workers or they can simply dial external business contacts by double-clicking. The software can utilise Outlook address books for contact lists.

#### Integration with IP Camera

Panasonic IP Camera can also be integrated, allowing users to answer a doorphone and open the door after viewing the IP camera video feed on screen.

#### Record conversations directly into Voice Mail (TVM50/200)

Allows Phone Assistant users to record the conversation that they are having with a caller.



Phone Assistant - intuitive user interface

View presence & availability.



## Phone Assistant Status for Supervisors and Team Leaders - Easy Call Monitoring



Business managers, supervisors, and team leaders can benefit from real-time monitoring of all team member telephony communication activities. The Phone Assistant Status application allows monitoring of up to 128 users - (combination of phone assistant users or normal phone extensions) with complete presence and availability information - perfect for any informal call centre.

Status users can pick up any ringing call being monitored, as well as silently Listen-in, Barge-in, or Take over a call. In addition - supervisors can even record a selected call - if required. Monitored extensions can also be flagged for easy identification - e.g. when monitoring a new employee or an agent in training.

### Monitor employee phone status / usage

Phone Assistant Status Pro users can monitor all configured incoming calls. Monitoring allows Status users to see not only all telephony activities but also settings of the monitored users, e.g. call forwarding, absent messages, etc.

### Extended reporting capabilities

The software supports extensive reporting capabilities with built-in reports as well as the ability to customize reports in order to keep track of all company telephony communications activities, such as the following.

- Status of monitored extensions
- History of all calls
- Output of call logs as CSV files

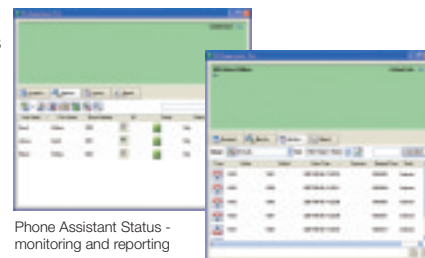

### System Connection Diagram

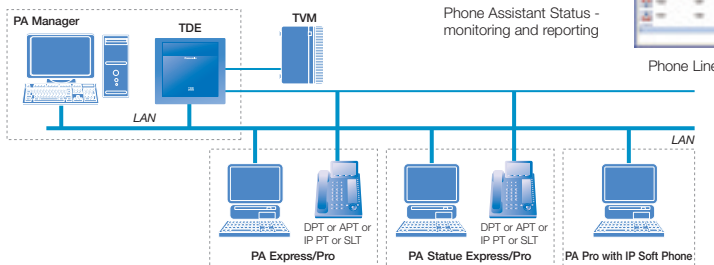

## Phone Assistant Manager for the tool of IT Administrators - Easy Maintenance



IT departments can use any networked PC with a standard web browser to use the Phone Assistant Manager to create and set Phone Assistant users as well as make typical Adds/Moves and configuration changes to their TDA/TDE IP PBX. Using this tool, customers can use self help to modify simple system and extension settings like:



- Modify System Date/Time and Holidays
- Add/Modify PBX speed dial numbers
- Set system wide absent messages
- Set Call Forwarding, Do-Not-Disturb, Call Waiting etc, and
- Assign flexible programmable keys

With a properly configured office IP network, authorised IT department personnel can even remotely access and configure basic TDA PBX settings from anywhere in the world they have access to the office network.

### Phone Assistant Express/Pro Specifications

Features	Express V1.5	Pro V1.5
User Capability	5 for TDA30, 10 for TDA100/200, 20 for TDA600	max 128 Users (Pro trial version : 2 for TDA30, 4 for TDA100/200, 8 for TDA600)

### Phone Assistant Status Express/Pro Specifications

Features	Express V1.5	Pro V1.5
User Capability	max 3 Users	max 8 Users
Extension Monitor	max 5 Extensions	max 128 Extensions

### Software List

Product Name	Model	Description
Phone Assistant Pro	KX-NCS1101	Software to control a telephone. License is required. KX-NCS1101 is for 1 license. KX-NCS1105 is for 5 licenses. KX-NCS1110 is for 10 licenses. KX-NCS1199 is for 128 licenses.
Phone Assistant Status Pro	KX-NCS1201	Software to monitor a call. A license is required. KX-NCS1201 is for 1 license.
Phone Assistant IP Soft-Phone Plug-In Module	KX-NCS9101	IP Soft-Phone Plug-In Module for PA Pro and PA Network Console. A license is required. KX-NCS9101 is for 1 license.
Phone Assistant Manager	KX-NCS1301	



# Informal Call Centre Systems

**Bring your distributed offices closer together with the ease of IP.**

## ACD Report Server

### KX-NVC200

ACD Report Server is designed to bring advanced call centre functions to users of Panasonic PBX systems, such as the KX-TDA100/200/600, KX-TDE100/200. This provides useful functions real-time monitoring and call centre performance reports, and agent log-in. Oftentimes, the difference between gaining or losing a new customer can hinge on a single telephone call. Panasonic's call centre solution makes sure that every telephone call works in your favour.



#### Real time Monitor

ACD (Automatic Call Distribution) Monitoring



#### Log Report

Trunk Call Report/ System Report



#### Real time Analysis

Performance Graphs



#### Voice Mail

### Screen of ACD Report Client



Performance Graphs



ACD Monitor



ACD Report

### System Connection Diagram

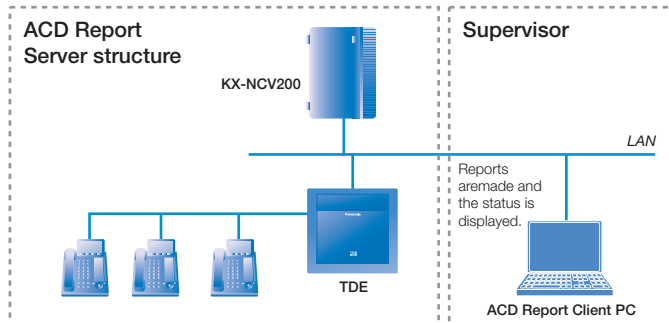

#### Optional Accessories

KX-TVM204	4 - Port Digital Expansion Card
KX-TVM296	Modem Card

## Voice Processing System

### KX-TVM50/TVM200

The human voice is still the best way to communicate. And with the KX-TVM50 and KX-TVM200, Panasonic introduces two feature-packed voice processing systems (VPS) designed for efficient communication. The KX-TVM50 and KX-TVM200 each offer automated attendant, automatic call routing, and message notification, and each can be customised to your needs.

#### KX-TVM50/200 Specifications

Number of Ports	KX-TVM50	KX-TVM200
Number of Ports	2 to 6	0 to 24
Voice Storage	Initial: 4h Max.:8h	Max. 1000 h
Number of Mailboxes (including System Manager and Message Manager mailboxes)	Max. 64	Max. 1024
Number of Messages	Unlimited	
Memory Media	Flash Memory	HDD
Remote Modem	Modem Card (Max. 33,600 bps)	

#### Optional Accessories

KX-TVM50			KX-TVM200		
KX-TVM502	2 - Port Hybrid Expansion Card	KX-TVM594	LAN Interface Card	KX-TVM204	4 - Port Digital Expansion Card
KX-TVM503	2 - Port Digital Expansion Card	KX-TVM296	Modem Card	KX-TVM296	Modem Card
KX-TVM524	Memory Expansion Card				

### System Connection Diagram

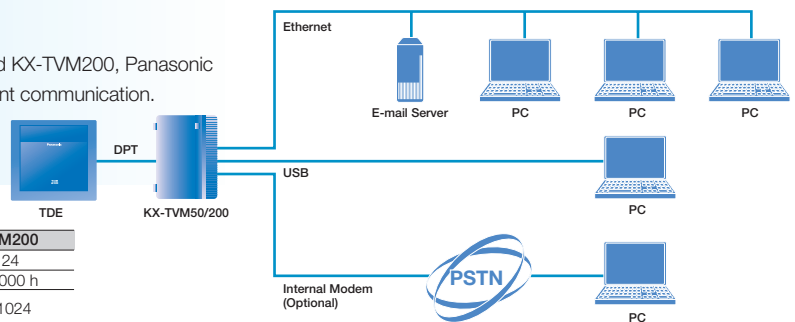



## IP Softphone

KX-NCS8102

### Mobility

Enjoy smooth communications through your PC with virtually the same level of functions that you would have if you had brought your office phone with you.

### Low Cost

There's no need for an off-site PBX or traditional telephone wiring.

### Transparent Integration

You can administer and operate IP telephones just like other extension telephones.

### Flexibility

IP technology lets you send data and voice over the same line.

### Around the world

For example, communicate with colleagues around the world with low cost and high efficiency.



### In home offices

For example, gain the same kind of benefits as if you had your own call centre right in your office at home.

### Application Examples

- Allows your employees to access the full functionality of your office telephone extension anywhere, anytime
- Staff can work remotely, efficiently & transparently
- Your business can also benefit from greater organisational flexibility

### IP Softphone on PC Screen

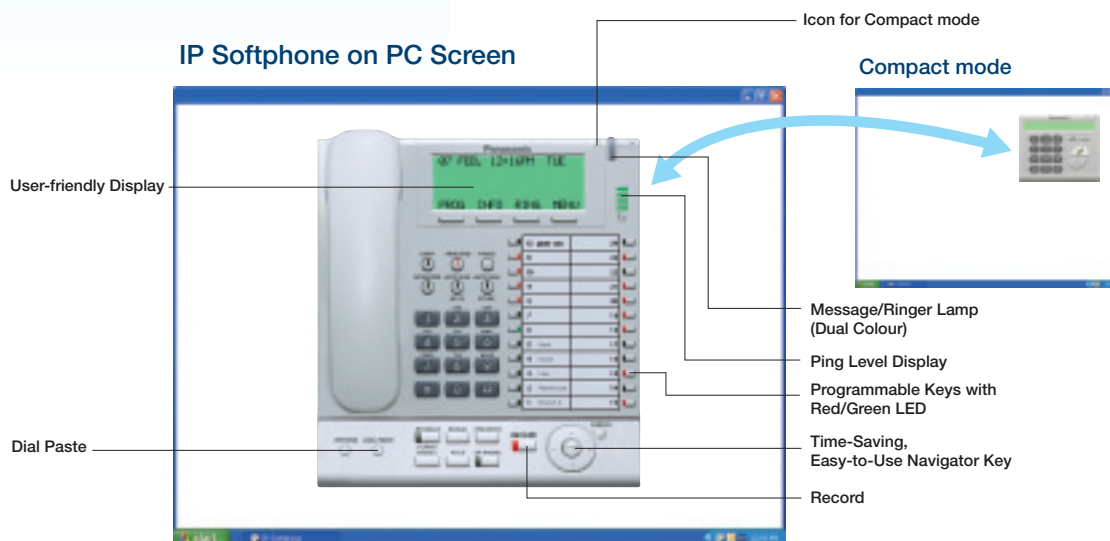

### Softphone Specifications

Alphanumeric Display (LCD)	6 lines x 24 characters
Programmable Keys with Dual Colour LED	24
Direct Station Selection (DSS) Keys with Busy Lamp Field (BLF)	Yes
Dial Paste	Yes
Record	Yes
Station Speed Dial	10 Numbers
USB Handset with Audio Ringer on PC	Yes
Peer to Peer Connection with NT300 Series	Yes

# Panasonic Office Communication Systems Are Ideal for Any Business, Any Location

For the majority of businesses, personal contact with the customer is a significant factor for success. The telephone system is at the heart of all communications – without any concern as to how the communication is conveyed: via IP, by traditional telephony or by employing wireless technology. What is crucial for businesses is quality and reliability. Panasonic provides wide variety of solutions to cover any individual requirements.



## Hotel

The Hospitality market requires the communications system to be flexible, economical, and easy to use, with maximum reliability and adaptability for the individual needs. The possibility of PC integration to allow guest room billing and system management has also become a requirement of this sector. The TDE Systems are perfectly equipped with all these necessary hospitality features and solutions.

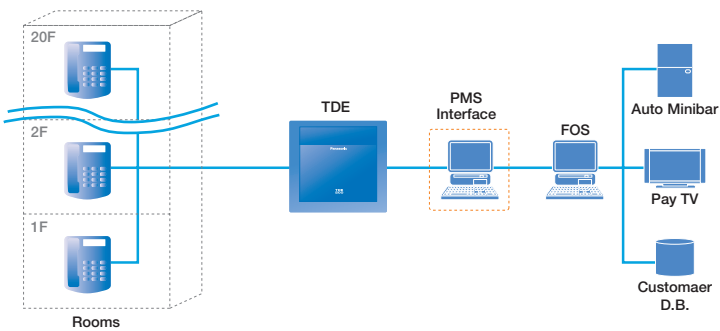

## Sales

In today's competitive world, personal contact becomes ever more important to the customer. Customer satisfaction, maximum flexibility and accessibility provide the crucial lead in this sector. With a solution from Panasonic, everything that you need is already built in as standard.

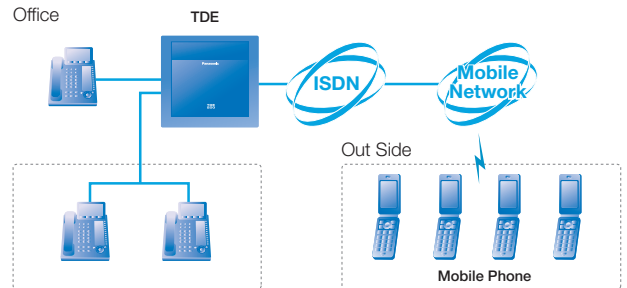

## Administration

Public administrations see themselves today more than ever as service providers. Their services must be carried out in spite of the increasing pressure of cost management for government, council and municipal authorities. Panasonic offers such establishments a telecommunications solution which helps them maintain and keep their costs in check.

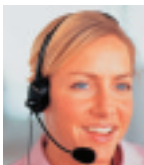

## Medical

To be able to work effectively and comfortably in a medical environment, it is necessary that the telecommunication system is adapted perfectly to fit the needs of this type of activity. In the field of health, Panasonic alleviates the continual increase in costs and allows easy integration with life saving technologies.



## Construction

Customers like to only invest in well built products, displaying them attractively and place them within a delightful environment. These same guidelines should also be followed by your telecommunication systems. When it comes from Panasonic - you are sure that all these important points have been meticulously followed - so customers can be proud to own a Panasonic system.







## Health Service

A telecommunication system in nursing facilities and resident housing must be consistent above all to the requirements of people in need. Panasonic offers custom-made solutions that can be integrated with computers to support administrative tools and emergency call systems. The investment ensures security by flexible, future-safe technology.

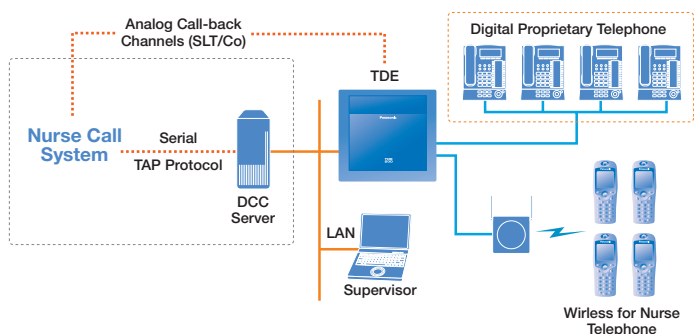

## Customer Service

We all would like to offer our customers the best service we possibly can, and while you might be the best today, what about tomorrow? Panasonic Telecommunication systems offer service-orientated solutions, which can be expanded to meet your customer's needs now and for days to come.

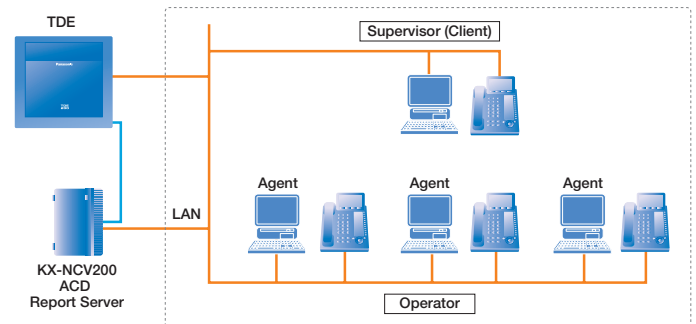

## Production Enterprises

High flexibility, economy and maximum reliability as well as adjustment to individual needs are important criteria, which telecommunication systems must fulfil. The KX-TDE outshines here as it was developed with manufacturing plants and production departments in mind. With its ultramodern design and future ready solutions, experience a new dimension of efficient communication.



## Logistics

Logistics requires smooth and reliable transport of information. This is why logistics companies have particular requirements when it comes to telecommunication systems. With possibility for integration into modern EDP systems and mobile accessibility, The KX-TDE systems can become the driving force for your business today, tomorrow and in the future.



## Legal

The legal industry of law firms, notaries, attorneys, solicitors etc have specific requirements when it comes to business communication. Attorney client conversation may need to be recorded - or clients may need to be billed for calls. Law firms may prefer to have secure entrances monitored via IP cameras. The KX-TDE addresses all these unique communication needs of the legal industry - yet provides all these and more solutions in a cost effective manner.



# The Panasonic Proprietary Telephone Line-Up

## IP Telephones

### KX-NT136

- IP Proprietary Telephone
- 6-Line Back-lit Display
- 24-Programmable Keys
- Digital Speakerphone
- 2nd Ethernet Port
- Power Over Ethernet (POE)



### KX-NT265

- 1-Line Display
- 8-Programmable Keys
- Message / Ringer Lamp
- Digital Speakerphone



## Digital Telephones

### KX-T7636

- Digital Proprietary Telephone
- 6-Line Back-lit Display
- 24-Programmable Keys
- Digital Speakerphone
- USB Connection (optional)



### KX-T7633

- Digital Proprietary Telephone
- 3-Line Back-lit Display
- 24-Programmable Keys
- Digital Speakerphone
- USB Connection (optional)



### KX-T7630

- Digital Proprietary Telephone
- 3-Line Display
- 24-Programmable Keys
- Digital Speakerphone



### KX-T7625

- Digital Proprietary Telephone
- 24-Programmable Keys
- Digital Speakerphone



### KX-T7665

- 1-Line Display
- 8-Programmable Keys
- Speakerphone



### KX-T7603

- Add-on Key Module (12 Co Keys)



## Analogue Telephone

### KX-T7710

- Proprietary Telephone
- 8-Programmable Keys
- Modem Data Port
- Message Waiting LED
- Ideal as an office or hotel room phone
- One-touch Button Panel



### KX-T7640

- Digital DSS Console (60 DSS)

